



Fiber Solution

NetWaySP1BTWP Series

802.3bt Media Converter/Injectors with
Integral Power

Models Include:

NetWaySP1BTWP

- 802.3bt Media Converter/Injector with Integral Power.
- NEMA4/4X rated outdoor enclosure.

NetWaySP1BTWPX

- 802.3bt Media Converter/Injector with Integral Power.
- NEMA4/4X rated outdoor enclosure.
- Accommodates up to four (4) 12VDC/4AH batteries.

Installation Guide



DOC#: NetWaySP1BTPWP Rev. 032620

More than just power.™

Installing Company: _____ Service Rep. Name: _____

Address: _____ Phone #: _____

Table of Contents:

Overview	<i>pg. 3</i>
Features	<i>pg. 3</i>
Recommended Altronix SFP Modules	<i>pg. 3</i>
Installation Instructions	<i>pg. 4</i>
Installation	<i>pg. 4</i>
Power Connection	<i>pg. 4</i>
Input/Data Connections	<i>pg. 4</i>
NetWaySP1BTWP	<i>pg. 5</i>
NetWaySP1BTWPX	<i>pg. 6</i>
Typical Application	<i>pg. 7</i>
Technical Specifications	<i>pg. 7</i>
Wall Mount Installation	<i>pg. 8</i>
Mechanical Drawing and Dimensions	<i>pg. 9-10</i>

Overview:

Altronix NetWaySP1BT Series 802.3bt media converter/injectors provide a single 802.3bt (4PPoE) port up to 90W and accommodate Fiber (1000Base-X/SX/LX) or structured cable to transmit data. Units can be deployed with structured cable, conventional single/multimode fiber or composite cable (fiber + copper combined). Cameras/edge devices may be located up to 100m from the unit.

Features:

Agency Listings:

- CE European Conformity.

Input:

- 115VAC, 60Hz, 2.5A or 230VAC, 50/60Hz, 1.3A.

Fiber Port:

- One (1) 1Gb SFP port.
**See below for recommended SFP modules.*

PoE Port:

- Single port rated up to 90W max.
- IEEE 802.3af, 802.3at and 802.3bt compliant.

Data Port:

- Connectivity: RJ45, auto-crossover.
- Wire type: 4-pair CAT5e and higher.
- Speed: 10/100/1000 Mbps.
- Distance: up to 100m.

Battery Backup:

- Built-in charger for sealed lead acid or gel type batteries.
- Automatic switch over to stand-by battery when AC fails.

Environmental:

- *Refer to Environmental Conditions on page 5.*

LED Indicators (Refer to Fig. 4, Pg. 4):

- **Yellow and Green LEDs** (RJ45 jacks):
Yellow (left) LED: 10/100 Mbps.
Green (right) LED: 1000 Mbps.
- **Green PoE LEDs:**
Indicate PoE present.
- **Green SFP (Fiber) LED:**
Indicates SFP connection.

Mechanical:

NetWaySP1BTWP:

- NEMA4/4X, IP66 Rated enclosure for outdoor use.
- Dimensions (H x W x D approx.):
13.31" x 11.31" x 5.59"
(338.1mm x 287.3mm x 142mm).

NetWaySP1BTWPX:

- NEMA4/4X, IP66 Rated enclosure for outdoor use.
- Accommodates four (4) 12VDC/4AH batteries (48V of backup).
- Dimensions (H x W x D approx.):
17.53" x 15.3" x 6.67"
(445.3mm x 388.6mm x 169.4mm).

Recommended Altronix SFP Modules:

Altronix P1MM, P1SM10, P1AB2K and P1GCE are hot-pluggable SFP fiber transceiver modules and are readily usable with all Altronix Spectrum fiber optic equipment for 1Gb transmission rates.

- P1MM** For use with Multi-Mode Fiber for distances up to 550m.
- P1SM10** For use with Single-Mode Fiber for distances up to 10km.
- P1AB2K** For use with Single Strand Single-Mode Fiber for distances up to 2km.
- P1GCE** For use with CAT5e or better for distances up to 100m.

Installation Instructions:

Wiring methods shall be in accordance with the National Electrical Code/NFPA 70/ANSI, and with all local codes and authorities having jurisdiction. All units should be installed by a trained service personnel.

Installation:

1. Remove backplane from enclosure prior to drilling. Do not discard hardware.
Note: Make sure that hardware will not interfere with components of the circuit board.
2. Mark and drill desired inlets on the enclosure to facilitate wiring. Maximum NEMA type 4X rated fittings to be used are 0.5". Follow manufacturer's specifications for the appropriate size opening.
Note: Inlets for conduit fittings should only be made on the bottom of the enclosure.
To facilitate wire entry utilize weather-tight NEMA rated connectors (*supplied*), bushings, and cable.
3. Clean out the inside of enclosure before remounting circuit boards/backplane.
4. Mounting NEMA4/4X rated enclosure (*Enclosure Dimensions, pg. 9, 10*):
Wall mount: Mount unit in desired location. Mark and drill holes to line up with the top and bottom hole of the enclosure flange. Secure enclosure with appropriate fasteners (e. g. screws and anchors; bolts and locking nuts, etc.) that are compatible with mounting surface and are of sufficient length/construction to ensure a secure mount (*Fig. 5, pg. 8*).
Pole Mount: Refer to *Fig. 6 - 10, pg. 8*.
5. Mount backplane in enclosure with hardware.

Power Connection:

Before powering unit, set input voltage selection switch to proper Input Voltage position (*Fig. 2a, pg. 5, Fig. 3a, pg. 6*). Units are factory set for 115VAC.

1. Connect AC power from overcurrent protective device circuit breaker (20A @ 115VAC, 60Hz or 16A @ 230VAC, 50/60Hz) to the terminals marked [L, N] on power supply board (*Fig. 2, 3, pg. 5, 6*). Connect ground lug to earth or green branch wire on backplane (12AWG min.). Use 14AWG or larger for all power connections (Battery, DC output, AC input).
Keep power-limited wiring separate from non power-limited wiring by utilizing separate knockouts/inlets. Minimum 0.25" spacing must be provided.
CAUTION: Do not touch exposed metal parts. Shut branch circuit power before installing or servicing equipment. There are no user serviceable parts inside. Refer installation and servicing to qualified service personnel.
3. **Battery Backup** (if desired): Connect four (4) 12VDC batteries wired in series to terminals marked [- BAT +] (*Fig. 3, pg. 5*), carefully observing polarity.
When use of stand-by batteries is desired, they must be lead acid or gel type.
Note: When batteries are not used, a loss of AC will result in the loss of output voltage.

Input/Data Connections:

1. Connect structured cable from port marked [Data Port] on NetWaySP1BT to a PoE midspan/endspan (*Fig. 1, pg. 4*).
2. Connect fiber optic cable to a fiber SFP module. Connect the module to the port marked [SFP] on the NetWaySP1BT. Connect the other end of fiber cable to an SFP module of a remote device.
SFP LED will illuminate indicating data connection (*Fig. 1, pg. 4*).
3. Using 4-pair CAT5e or higher cable connect PoE load device to be powered to the port marked [802.3bt Output] on NetWaySP1BT. After authentication and classification have been established, [PoE Signal] LED will illuminate indicating PoE presence.

Fig. 1

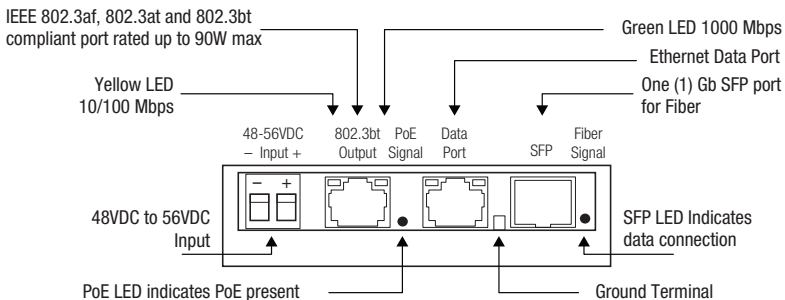

Fig. 2 - NetWaySP1BTWP

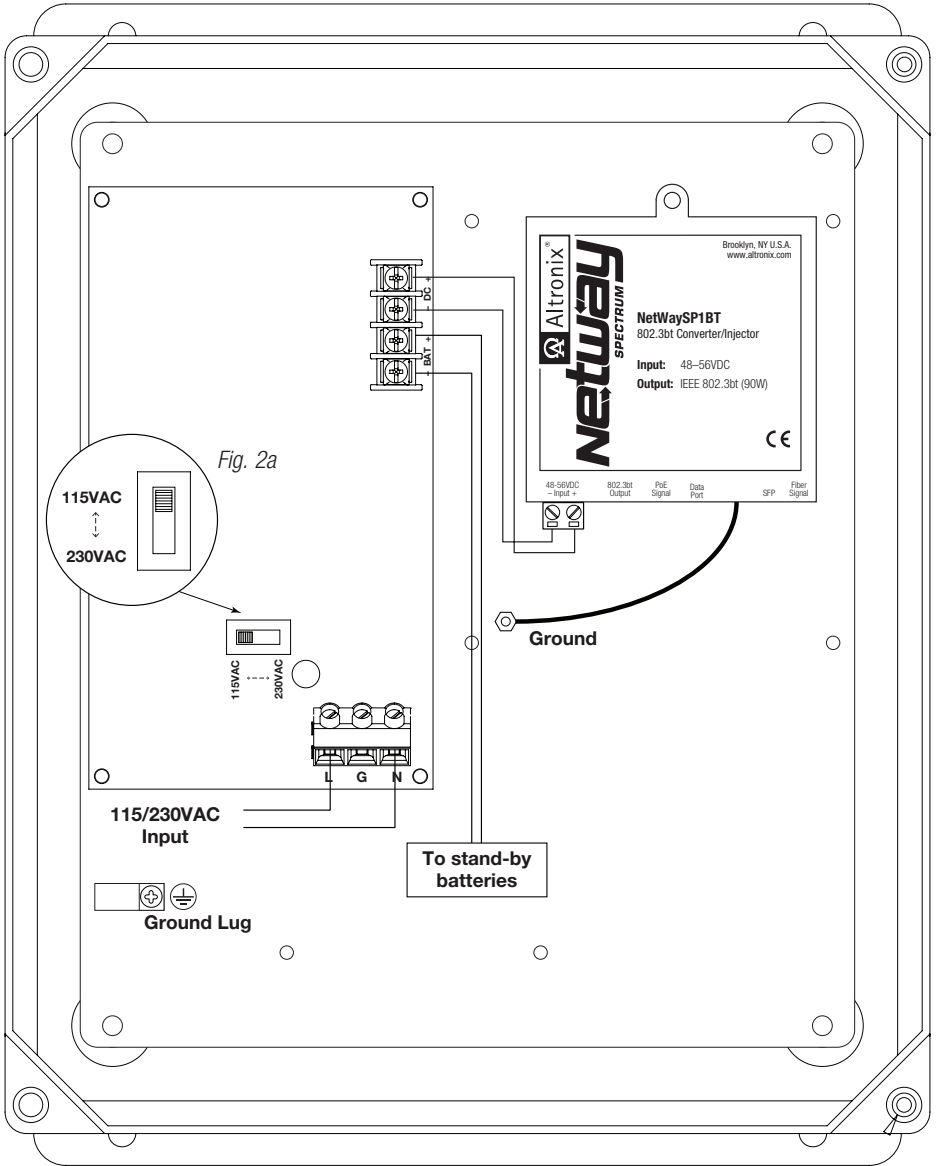

Fig. 3 - NetWaySP1BTWPX

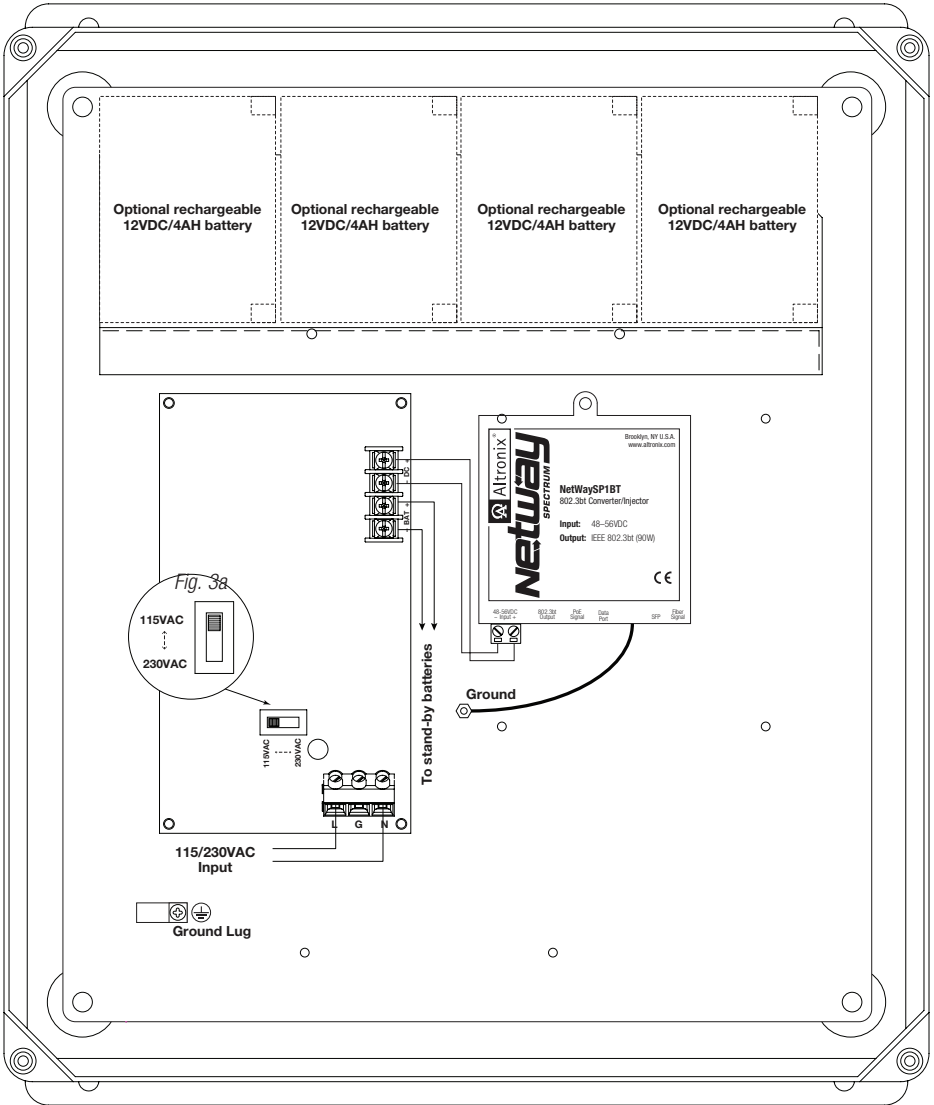
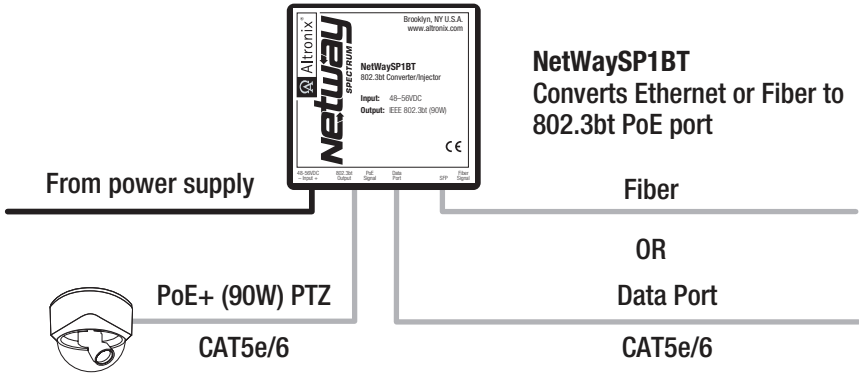



Fig. 4

Typical Application:



Technical Specifications:

Parameter	Description
Ports	One (1) 1Gb SFP port, one (1) Data port. One (1) IEEE 802.3af, 802.3at and 802.3bt compliant output port rated up to 90W max.
Input Power Requirements	115VAC, 60Hz, 2.5A or 230VAC, 50/60Hz, 1.3A.
Indicators	Yellow and Green LEDs (RJ45 jacks): IP Link status, 10/100/1000 Base-T/active. PoE Green LED: Indicates PoE present. Fiber Signal Green LED: Indicates SFP connection.
Environmental Conditions	Temperature: Operating: 60W: -40°C to 75°C (-40°F to 167°F). 80W: -40°C to 70°C (-40°F to 158°F). 90W: -40°C to 60°C (-40°F to 140°F). Storage: -40°C to 85°C (-40°F to 185°F). Relative Humidity: 85% +/-5%. Operating Altitude: -304.8 to 2,000m.
Regulatory Compliance	 CE European Conformity.
Weights (approx.)	NetWaySP1BTWP: Product: 10.5 lb. (4.76 kg) Shipping: 11.9 lb. (5.4 kg). NetWaySP1BTWPX: Product: 15 lb. (6.8 kg) Shipping: 17.5 lb. (7.9kg).

Wall Mount Installation:

- 1- Place unit at desired location and secure with mounting screws (not included) (Fig. 5, pg. 8).

Fig. 5

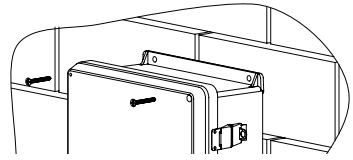

Pole Mounting Using Optional Pole Mount Kit PMK1 (NetWaySP1BTWP) or PMK2 (NetWaySP1BTWPX):

This installation should be made by qualified service personnel. This product contains no serviceable parts. PMK1 and PMK2 outdoor pole mount kits are designed to simplify the installation of Altronix outdoor rated power supplies and accessories housed in models WP1, WP2, WP3 and WP4 NEMA rated enclosures. PMK1 and PMK2 can be mounted on 2" to 8" (50.8mm to 203.2mm) diameter round or 5" (127mm) square poles. Brackets are designed for use with the Wormgear Quick Release Straps (two included).

1. Thread one (1) wormgear quick release strap through the slots on the back of a mounting bracket (Fig. 6, pg. 8).
2. Once the desired height of the top Pole Mount bracket is achieved, tighten the straps down by sliding open end of the strap through the locking mechanism on the strap, then tighten the screw with flat head screwdriver or 5/16" hex socket driver (Fig. 7, pg. 8 and Fig. 9, pg. 8).

Fig. 6

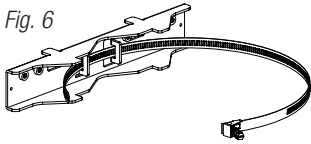

Fig. 7

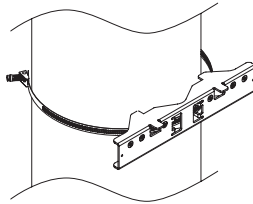
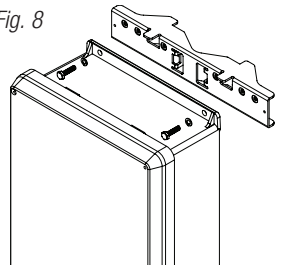

Fig. 8



3. Attach the bottom bracket to the enclosure by inserting bolts through the flange of the enclosure and into the bracket, tightening bolts with a 7/16" hex socket (Fig. 8, pg. 8).
4. Thread the second wormgear quick release strap through the slots on the back of the bottom mounting bracket (Fig. 9, pg. 8).
5. Mount enclosure onto the top bracket by inserting bolts through flange of the enclosure and into the bracket, tightening bolts with a 7/16" hex socket (Fig. 7, pg. 8).
6. Tighten the straps of the bottom bracket down by sliding the open end of the strap through the locking mechanism on the strap, then tighten screw with flat head screwdriver or 5/16" hex socket driver (Fig. 7, pg. 8).
7. Clip excess straps.

Fig. 9

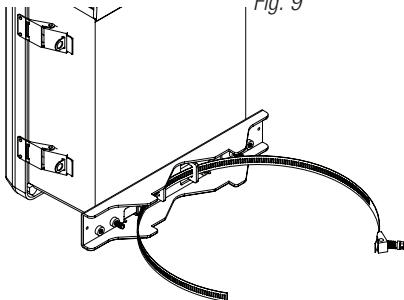

Fig. 10

2" to 8" (50.8mm to 203.2mm)
diameter round pole

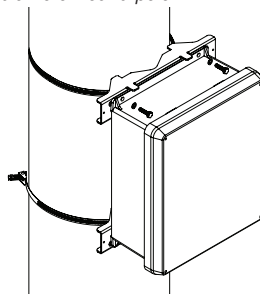
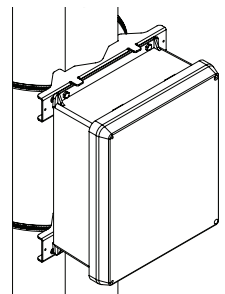

Fig. 10a

5" (127mm) square pole



NetWaySP1BTWP

Enclosure Drawing and Dimensions (H x W x D approx.):

13.31" x 11.31" x 5.59" (338.1mm x 287.3mm x 142mm)

FRONT VIEW

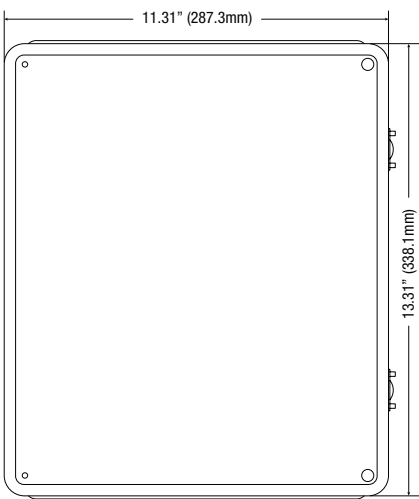

RIGHT SIDE VIEW

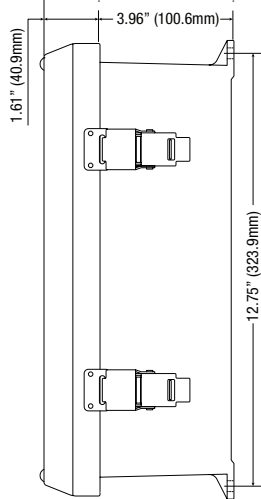

FRONT VIEW COVER REMOVED

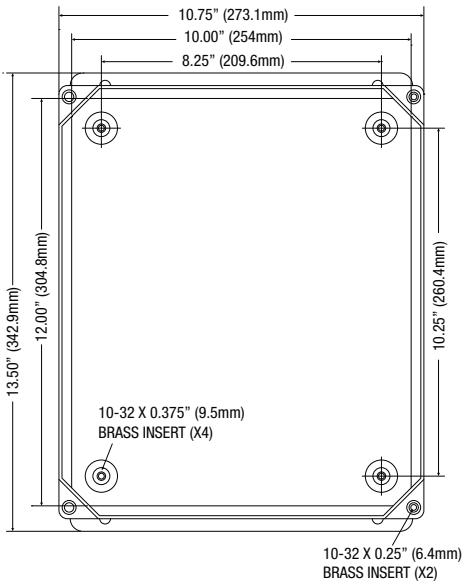

END VIEW

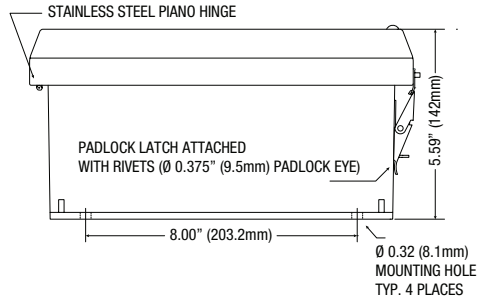

NetWaySP1BTWPX

Mechanical Drawing and Dimensions (H x W x D approx.):

17.53" x 15.3" x 6.67" (445.3mm x 388.6mm x 169.4mm)

FRONT VIEW

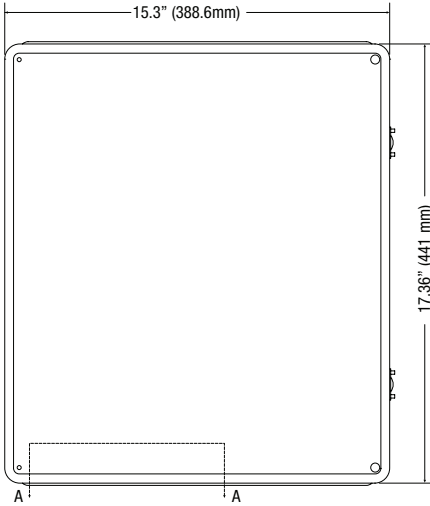

RIGHT SIDE VIEW

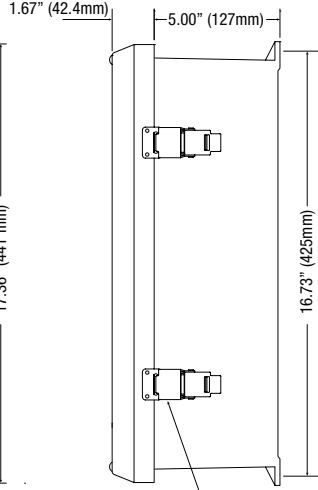

316 STAINLESS STEEL PADLOCK LATCH
ATTACHED WITH RIVETS. Ø 0.375 PADLOCK EYE

FRONT VIEW COVER REMOVED

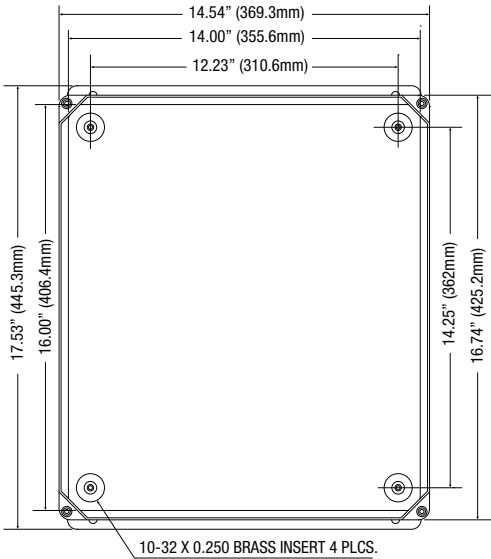

SECTION A-A

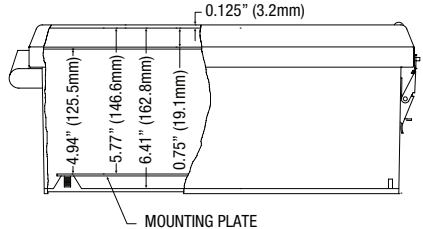

END VIEW

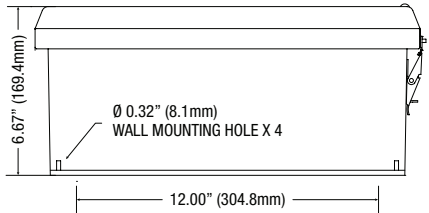

Notes:

Notes:

Altronix is not responsible for any typographical errors.

140 58th Street, Brooklyn, New York 11220 USA | phone: 718-567-8181 | fax: 718-567-9056
website: www.altronix.com | e-mail: info@altronix.com | Lifetime Warranty
IINetWaySP1BT Series Powered G08U

